

# The use of terrestrial laser scanning in archaeology Evaluation of a Swedish project, with two examples

Tony Engström\*<sup>1</sup> & Mikael Johansson<sup>2</sup>

\* *Corresponding author (tony.engstrom@sau.se)*

<sup>1</sup> *Societas Archaeologica Upsaliensis (SAU), Villavägen 6G, SE-752 36 Uppsala, Sweden*

<sup>2</sup> *GIS institute, Department of Technology and Built Environment, Division Geomatics, University of Gävle, SE-801 76 Gävle, Sweden*

The terrestrial laser scanning technique is attracting more and more attention as a useful method in several areas of surveying and documentation, slowly finding its place even in the field of archaeology and the cultural heritage. It offers a fast and precise way of documenting both large areas and single small objects, and the resulting 3-dimensional digital models can be used in various ways, e.g. for spatial analyses, archaeological interpretation and public display. During the years 2003–2005, a collaborative project evolved between archaeologists at Societas Archaeologica Upsaliensis (SAU) in Uppsala and surveyors at the GIS Institute and 3DFocus in Gävle. The original overall aim of the project was to try out the laser scanning method in an archaeological environment and investigating its potential as an alternative, fast and cost-effective means of documentation. The results were quite satisfactory and made archaeologists realize the great potential of the method, but also pointed to some technical limitations and obstacles. Several archaeological sites have been scanned over the last few years and this article discusses the documentation of two excavations of different kinds, carried out in 2003 and 2004 respectively.

*Keywords:* laser scanning, 3D-rendering, pulsed time-of-flight, terrain model, topography

## Introduction

Archaeological excavations were carried out during the years 2002–2004 on account of the construction of the E4 motorway between Uppsala and Tierp in the county of Uppland, in connection with which collaboration developed between surveyors at the GIS Institute at Högskolan i Gävle, the laser scanning company 3DFocus in Gävle and archaeologists at Societas Archaeologica Upsaliensis (SAU) in Uppsala in 2003. This collaborative project took the form of pilot research aimed at trying out the Terrestrial Laser Scanning (TLS) technique, using a Cyrax 2500 “pulsed time-of-flight” laser ranging scanner as an additional documentation and measuring device in an archaeological excavation environment.

This article deals in particular with the laser scanning of two prehistoric sites of different kinds within the E4 project. The first one, Sommaränge skog, scanned in 2003, was a large, complex site situated about 25 kilometres north of Uppsala and consisting of various ritual and non-ritual remains dating from the Late Neolithic to the Medieval Period (Schmidt Wikborg 2006; Forsman & Victor 2007), and the second one, Skallmyran, about 10 kilometres south of Tierp in northern Uppland, was a Late Mesolithic fishing and hunting site where the topography formed a very favourable setting for a temporary settlement and had been the determining element for Mesolithic activities (Guinard & Vogel 2006). This was actually the first time that the TLS technique had been used in Swedish archaeology as a means of documenting

topographic conditions in an excavation area. Both the archaeologists and the surveyors learned a great deal about the prerequisites for such work and gained some useful knowledge for future scanning.

### Background to laser scanning

One of the most fundamental of all surveying principles is the need to measure distance. Rulers and measuring tapes have been used, and are still used, for straightforward distance measurements, but electronic distance measuring (EDM) units are now available for use where more accurate results are required. The first EDM, called the geodimeter (geodetic distance meter), was actually introduced by the Swedish physicist Erik Bergstrand in the 1940s (Smith 1997), and nowadays EDM units are combined with digital theodolites and microprocessors to form total stations capable of measuring both distances and angles, and often also calculating, recording and displaying horizontal and vertical distance components and coordinates. In addition to traditional surveying, photographs have also played an important role in the documentation of objects, and here enhanced accuracy and even more powerful products can be obtained by using metric cameras, photogrammetric methods and stereo measurements.

The laser scanning technique has now entered the field of surveying as one of the most important methods for "as built" documentation. The practical

development of laser scanners has closely followed the availability of new electronic components and emerging electro-optical technologies (Blais 2003). Laser scanning was initially introduced during the 1980s for close-range scanning and accurate and detailed measurements of small objects, e.g. in the manufacturing industries, and later systems for measuring relatively long distances were introduced, often mounted on airborne platforms and specially constructed for the documentation of landscapes and the producing of accurate terrain models. Terrestrial, or ground-based, laser scanner systems found their way onto the market in the mid-1990s.

Both airborne and terrestrial laser scanning are now relatively well-established methods for the acquisition of precise and reliable three-dimensional geo-information. Apart from its primary tasks in the generation of digital terrain models, airborne laser scanning has also proved to be a very suitable tool for general three-dimensional modelling and landscape analysis, while terrestrial laser scanning has been used successfully to acquire highly detailed terrain models and surface models of objects such as building façades, statues and industrial installations.

### Laser scanning technology

Measurements made with a terrestrial laser scanner are in general very similar to those made with a total station, i.e. laser ranging techniques allow one to measure

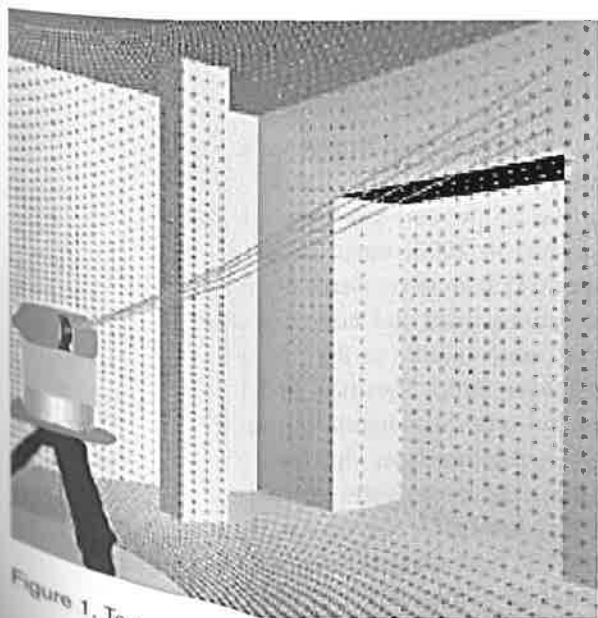

Figure 1. Terrestrial laser scanning (TLS).

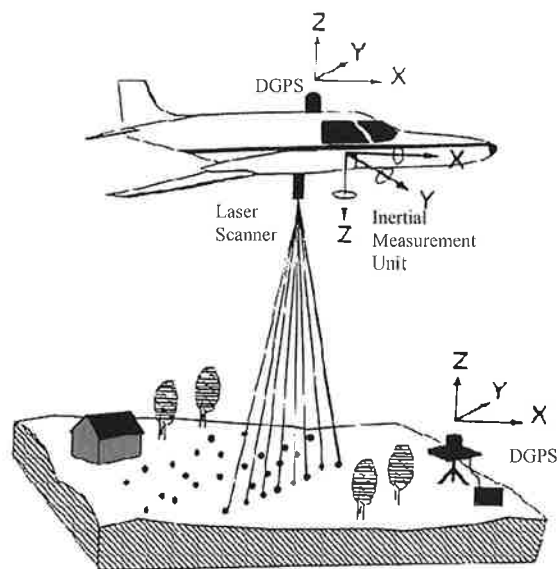

Figure 2. Airborne laser scanning.

### Pulsed time-of-flight ranging

$$d = \frac{c\Delta t}{2}$$

d = distance between instrument and target  
 c = speed of light  
 Δt = flight time of pulse, from transmitter to receiver

### Modulated multi-frequency continuous wave ranging

$$d = \frac{x + n\lambda}{2}$$

d = distance between instrument and target  
 x = phase difference  
 n = number of "full" wavelengths  
 λ = wavelength

### Optical triangulation ranging

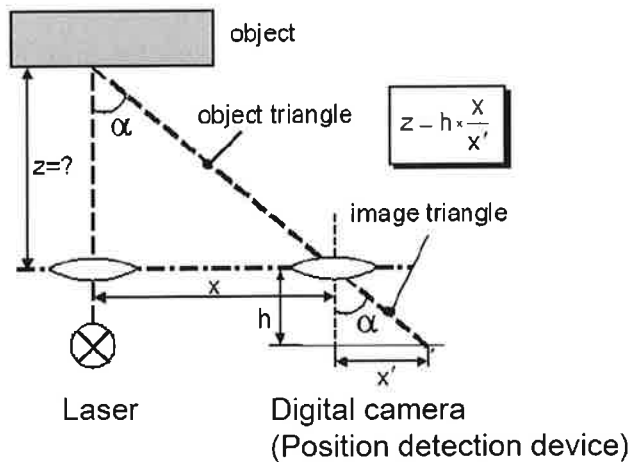

Figure 3. Three types of laser ranging technique: pulsed time-of-flight, modulated multi-frequency continuous wave (CW) and optical triangulation.

distances from objects, vertical and horizontal angles and the positions of the measured points with respect to the system's centre of origin. Some kind of deflection device, usually made of mirrors or glass prisms, is used to point the laser beam systematically in different directions in small incremental horizontal and vertical steps, thus covering the object to be scanned. The visualised result is usually called a "point cloud" (Fig. 1). Distances can be measured with respect to objects composed of almost any kind of material, i.e. they can be reflectorless objects, requiring no reflecting prism to be fitted to them. Laser scanners are also much faster than most of today's total stations having a reflectorless measurement capability, making

speed the outstanding character that distinguishes between the two types of system. TLS systems are usually ground based and stationary during measuring, allowing them to be positioned in similar ways to total stations. Airborne laser scanners, on the other hand, consist not only of a ranging laser unit and a deflection unit but also of a positioning and orientation unit that continuously keeps track of the actual position and orientation of the system, i.e. of the helicopter or aircraft, in the air during the scanning mission (Fig. 2). Since laser scanning systems are active, they can even work in complete darkness. In other respects, however, TLS systems in particular are relatively sensitive to the operation conditions and do not work well

in rain or snow, nor will most systems available today operate at sub-zero temperatures (Celsius).

It is possible to distinguish three ranging principles used in laser scanners (Fig. 3). The first is pulsed time-of-flight laser ranging, which is probably the most obvious method for operating a laser ranging system, because the actual time of flight is measured directly. This is the predominant technique for airborne systems and for long-range TLS systems, and involves accurate measurement of the time of flight of a laser pulse from the instant when it leaves its source to the instant when, having reflected off the object and returning to the instrument, it is detected by the system and stops the measurement clock. Since we know the speed of light, the distance from the object can be calculated from half the travel time. Secondly, various kinds of modulated multi-frequency continuous wave (CW) ranging devices are becoming more and more popular amongst TLS systems. One advantage of these is the high measuring speed that can be attained and the theoretical possibility for greater ranging accuracy. These instruments measure the phase difference between sent and received signals rather than the direct turn-around time for a light pulse. Since the frequency is known, the measured phase plus number of complete wavelengths will directly correspond to the time of flight, i.e. the distance. The number of complete wavelengths can be measured using a second frequency with a wavelength larger than twice the maximum range. The third method, optical triangulation, as illustrated in the simplest case in Figure 3, is usually used for close-range laser scanning of small objects. By sending a laser beam from one end of a mechanical base to the object at a defined and incrementally changing angle and using a digital camera device to detect the laser spot on the object at the other end of this base, the 3D position of the reflecting surface element can be derived from the resulting triangle.

### Characteristics of a TLS system

Many surveying problems that it was more or less impossible to solve by traditional methods can now be solved with the help of terrestrial laser scanning. Although all terrestrial laser scanning systems offer numerous possibilities, it is important to remember that there is no universal TLS system available for all conceivable applications. Some systems are more suitable for indoor use and medium ranges, 1–50 metres, while others are better suited for outdoor use and long ranges, up to several hundred metres. There are also a fairly large number of close range scanners suitable for

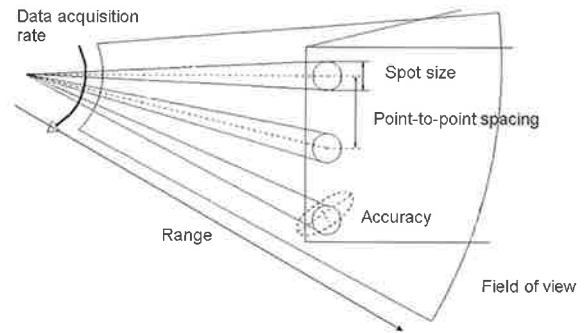

Figure 4. TLS system characteristics.

smaller objects and ranges up to a few metres. Some characteristics that it is important to take into account when selecting a suitable TLS system for a particular application are indicated in Figure 4.

- Range – maximum and minimum range. How far can the system measure and how close to the scanner can an object be placed?
- Data acquisition rate. How fast is the scanner?
- Field of view – volume that can be covered in one scan.
- Accuracy – ranging, angular and combined positional accuracy for a point.
- Spot size. How small are the details that can be scanned? How small are the openings that can be penetrated?
- Resolution – point-to-point spacing. How small are the details that can be scanned?

All the characteristics listed can be more or less important depending on the type of application. A TLS system with high accuracy, small spot size and small point-to-point spacing should be preferred when a high level of detail and high accuracy is required, while a system with a high data acquisition rate should be selected when access to the area to be scanned is limited in terms of time. When measuring objects composed of different types of material, it is obvious from reading the technical specifications that poorly reflective materials will influence the possible maximum range of the scanner. In some circumstances it may be impossible to get any reflection off the material at all, which means reflectorless measuring techniques (i.e. terrestrial laser scanning) cannot be used.

In addition to characteristics listed above, environmentally determined operational specifications might be of importance, and the size, weight and power

supply of the scanner may also place limitations on its use. Quite a few questions thus need to be answered before deciding what system to choose for a certain application. Some of these questions are answered in the laser scanner product survey provided by Point of Beginning (2005).

### Terrestrial Laser Scanning and archaeology

Even though the method is still rather new, 3D terrestrial laser scanning has been used in an increasing number of archaeological contexts around the world during the last couple of years. Stonehenge in southern England is one example. By scanning the stones, archaeologists have been able to discover several previously unknown carvings and have at the same time obtained an excellent digital documentation of the already known ones as well as a detailed three-dimensional digital model of the monument as a whole. This model has been used for further analysis and for public display at exhibitions and on the Internet (Brayne et al. 2003; Wessex Archaeology/Archaeoptics 2005). Other examples are the scanning of rock paintings in Australia (El-Hakim et al. 2004), the "Grime's Graves" Neolithic flint mines in Norfolk, England (English Heritage 2005), and tombs in The Valley of the Kings in Egypt (Ahmon 2004).

In the case of the Australian rock paintings, photographs were draped on the scanned model by means of a photogrammetric technique, resulting in three-dimensional digital copies of the art, while in the English flint mines, where traditional techniques offered limited documentation possibilities due to the very narrow passages, laser scanning provided a means not only of performing exact, comprehensive measurements but also of re-creating the mines in the form of three-dimensional digital models. With the Egyptian tombs, archaeologists took the technique yet one step further by scanning them in order to make full-scale copies for public exhibitions.

In Sweden, Dr. Laila Kitzler Åhfeldt at the Archaeological Research Laboratory (AFL) at Stockholm University has been using another laser scanning technique for several years, documenting rune stone carvings and carrying out microtopographical studies. The method has proved highly successful for distinguishing between rune carvers by reference to the carving technique that they used (Kitzler Åhfeldt 2002). The results of these microtopographical measurements somewhat resemble a full-scale topographical terrain model, although the laser scanning method and the aim of the work are both rather different.

### Terrain modelling

Prehistoric human activities most often seem to have had an active and meaningful relation to the landscape and to variations in the terrain. Graves and other monuments were frequently situated on high land, preferably adjacent to communication routes such as roads, trails or rivers, in order to be seen by as many people as possible. Mesolithic hunting stations and temporary settlements were often situated in sheltered places near water, preferably on the coast. Given that our modern landscape is in a state of constant change, through cultivation, forestry and modern colonization, it is unfortunately often hard to discern the nature of the prehistoric conditions. Another aggravating circumstance is of course the fact that northern Uppland is exposed to a considerable degree of land uplift, which in combination with the rather flat landscape means that the Mesolithic coastal settlements and hunting stations are now to be found about 50–60 metres above sea level and several kilometres inland.

To gain a sufficient understanding of the prehistoric human activities it might be important to picture the special environmental conditions that prevailed at the site. Furthermore, because most archaeological excavations usually take place owing to some kind of projected exploitation of the site, it is seldom possible to return later to carry out additional topographical studies. Thus a terrain model might be a useful and pedagogically sound foundation for understanding an archaeological site and its topographical conditions while still excavating it, and also for providing a post-excavation view of the topographic circumstances, which might not be revealed in a satisfactory way in a photograph, for example.

The traditional surveying methods used in archaeology offer quite limited possibilities when it comes to detailed documentation of topography. It is true that the introduction of total stations and GPS has made it possible to some extent to create useful 3D renderings of surface variations, but the creation of terrain models is far from being a standard procedure in connection with archaeological excavations. Even in cases where such a model might seem to be called for, on account of a monument's close relation to specific high points, for example, or because of some other topographical influence on certain activities, it is not always produced. This somewhat reluctant attitude towards documenting height variations is almost certainly due to the effort required. Creating a terrain model by painstaking measurements of individual points over large areas is certainly both a rather costly undertaking and time-

consuming trial of one's patience. The laser scanning method, measuring thousands of points a second, undoubtedly makes the job easier.

### The Sommaränge skog example

The excavations at the Sommaränge skog site were carried out in 2003 over an area of approximately 25 000 m<sup>2</sup> and revealed a wide range of prehistoric remains, the most salient of which were those alluding to ritual activities during the Bronze Age (dated to 1800–500 BC), including three major heaps of fire-cracked stones. The largest of these heaps contained several cremations and covered an oval stone setting that to all appearances had contained an inhumation burial and depositions of cremated human bones together with pottery and a piece of golden wire. The largest heap also contained finds of ceramics, burnt animal bones, stone tools and a bronze “razor”. Cremation grounds with several layers of charcoal, a small quantity of bones, ceramics and a whetstone were uncovered beneath the other two heaps. The ritual remains also included a monumental cairn-like stone setting, several smaller stone constructions containing cremation remains and some areas without visible grave markers but still sprinkled with cremated bones. Traces of a palisade enclosure and a small ritual house can also be assigned to the Bronze Age. Parts of a hollowed path which had probably run through the whole area were found in two places, and, there were cup-marked boulders at the northern and southern ends of the area, evidently indicating the boundaries of the ritual activities. Five graves dated to the Migration Period (AD 400–550) and containing typical findings of clasp buttons, iron dress-pins, bear phalanges, combs and cremated bones were found in the outer parts of the excavation area, and a medieval farmstead with several houses and an adjacent fireplace, forge, well and a brick-making kiln were found around and on top of a small terrace to the north. The constitution of the farmstead and the objects found in conjunction with it indicated that it had been an upper-class dwelling in the 14th century.

From a topographical point of view, however, it was the relations between the monuments and the variation in heights that made the area suitable for 3D laser scanning. There were no high hills on the site, but quite a few smaller hillocks and low till ridges stretched out over the area, making it a somewhat undulating landscape (Fig. 5). All of the distinct, well-marked graves and the heaps of fire-cracked stones were situated on these high points. As mentioned above, the medieval

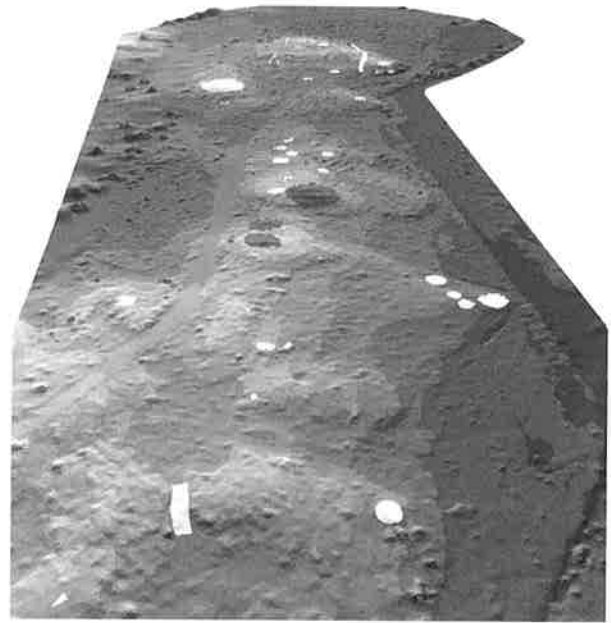

Figure 5. Terrain model of Sommaränge skog with some of the archaeological objects marked: hollowed paths, stone settings and heaps of fire-cracked stones (centre). The view is from the south and covers a scanned area of approximately 300 × 100 metres.

houses were also situated on a terrace formation on one of the heights, as were the visible parts of the hollowed path. On the other hand, the more diffuse stone constructions were in several cases to be found in the lower-lying parts, as was the case with the medieval forge, the well and the brick-making area.

The Sommaränge skog site was initially scanned prior to taking off the topsoil. In order to cover the area satisfactorily, the Cyrax 2500 scanner from Leica, with a maximum range of 100 metres, was set up at six locations. The point clouds from these locations were related to each other by reference to targets with known positions using the Cyclone software, also from Leica, which is specially devised for laser scanning applications. Ten targets well distributed over the Sommaränge skog site and its surroundings were used for this purpose, and the scanning was carried out in about one day of actual fieldwork time. The point cloud generated from this initial scan consisted of about 12.5 million measured points, every one of which was related to the reference grid of x, y, and z coordinates used in the excavation. After meshing the point cloud into a 3D terrain model that could be zoomed and turned to all possible angles, the archaeological objects, positioned using the total station, were merged into the model using 3D ArcGis 9 software

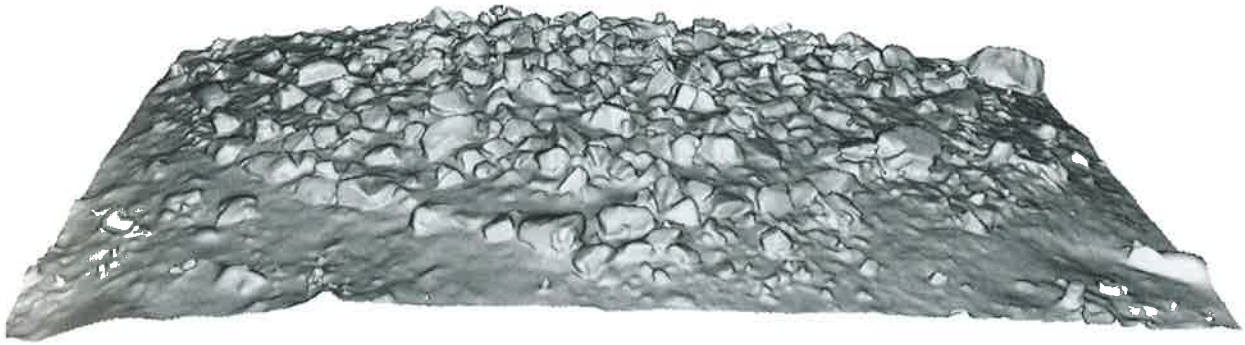

Figure 6. Part of the scanned stone setting (Ø15 m) at Sommaränge skog.

developed by ESRI. The result was a model containing both terrain variations and archaeological artefacts, thereby making it possible to return to the excavated area in digital form (see Fig. 5). Given adequate software, differences in height can also be intensified visually, either by using colours or forms of illumination or by experimenting with different z parameters.

At a later stage in the excavation the cairn-like stone setting was scanned (Fig. 6) in order to test how the method could be used to facilitate or replace some of the traditional measuring and drawing by hand. Amongst other things, a two-dimensional drawing was extracted from the raw data in order to see to what extent the computer could render the stones as polygons. Finally, one of the cup-marked boulders was scanned as well. The scanning of the stone construction and the cup marks is discussed below in the evaluation section.

### The Skallmyran example

In the case of the Skallmyran excavation, carried out in 2004, no traces of prehistoric activities could be seen beforehand and attention was only drawn to the site on account of its location in the landscape. A small terrace almost completely free of stones and lying on a south-facing slope sheltered by higher ground with till stones and boulders was found to contain a hearth, some burnt seal bones and traces of quartz tool manufacturing. The site was situated about 55 metres above sea level, the level corresponding to the Late Mesolithic or Early Neolithic (4000 BC) coastline in northern Uppland. At that time the area to the south consisted of a small bay close to the terrace, so that the topography provided an excellent landscape for a halting place or temporary settlement. By the time of the Mesolithic activities the site was part of a longish island in the

archipelago, not far from the mainland.

It became clear early on in the excavations that these topographic circumstances were worth recording, and in view of previous experiences with scanning at Sommaränge skog, this method seemed obvious. A terrain model would be a good way of visualizing the special conditions prevailing at Skallmyran, offering an even better understanding of the surroundings and the prerequisites for life at the site. The scanning was carried out prior to taking off the topsoil but after felling the trees at the excavation site, and it also took in a rather large area of the surroundings where the trees had not been felled. These woody parts and some other disturbing objects such as excavators, construction huts and cars were later edited out from the final model.

The result is a terrain model in which the height variations appear clearly and to which a spreadsheet of findings and excavated squares can be added to construct a good overall view (Fig. 7). Furthermore, a rectified photograph taken from above by a hang glider was draped on the 3D surface (Fig. 8). To clarify the influence of land uplift, the water level during the Late Mesolithic was simulated in relation to the heights in the model (Fig. 9). With sufficient software one can quite easily make figures or even animated films of the changes in the coastline over time.

### Evaluation

The Sommaränge skog and Skallmyran sites proved to be good examples of close relations between prehistoric activity and the topography of the landscape. In both cases the relations between the archaeological objects and the hillocks and low till ridges were actually something one could have a presentiment of at the time of excavation, but the extent of these relations became



Figure 7. Terrain model of Skallmyran with excavated areas and simulation of the quartz frequency by weight (performed using the Surfer software). The view is from the south and covers a scanned area of approximately 100 × 100 metres.



Figure 8. Scanned model of the terrace area at Skallmyran, with excavated areas. A photograph is draped on the surface. The view is from the north and covers a scanned area of approximately 65 × 50 metres.

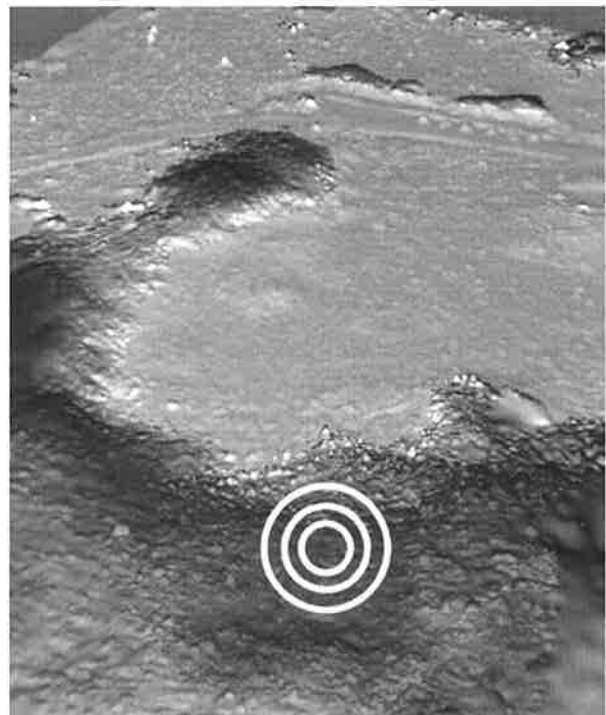

Figure 9. Scanned overview of Skallmyran with the simulated Late Mesolithic water level, viewed from the north. The topography forms a sheltered bay. The area marked with finds pointing to Mesolithic activities is approximately Ø30 metres.



even clearer after creating the 3D model and merging it with the other findings. In that sense, scanning contributed to and clarified our understanding of the prehistoric landscape and the relations of the archaeological objects to it. Furthermore, the 3D model serves as a good supplementary form of documentation that makes it possible even now to return to digital versions of the areas and reconsider their topographical conditions even though the sites have been levelled out and a motorway built over them.

The original overall aim of the laser scanning project was to try the method out in an archaeological environment and investigate its potential as an alternative, fast and cost-effective means of documentation. The results soon made us realize, however, that this technique by far exceeds the mere creating of traditional contour or wire netting terrain models, and that it would be possible to conceive of a wider range of uses for laser scanning, as an analytical instrument as well as a documenting tool.

With all deference to the accuracy, speed and tidiness of 3D models, there is of course another side to the coin as well, and there are good reasons to stress some of the practical problems and limitations experienced. Both sites were situated in fairly dense coniferous forest, and although the trees had been felled and the larger branches cleared away along with the timber, quite a large quantity of twigs remained. This came to affect the results in two ways. On the one hand, the thick layer of twigs tended to smooth over the surface in a way that disturbed the recording of small differences in height such as those caused by pits or stones, and on the other hand, twigs and branches sticking up here and there caused problems with the triangulation of the point cloud or its mesh into the 3D surface. In cases where the laser pulse happened to hit such objects, the computer tended to include these points in the triangulation as well. The same thing was also true of other transient objects such as cars or people. Such unwanted hits could generate odd-looking spikes in the modelled surface. In order to eliminate these disturbances, or, as in the examples discussed here, the effects of surrounding wooded areas, it is necessary to filter the data set and smooth the surface (making it either pixelled or blurred). This can be done mainly in two ways: either by automatically filtering all the raw data in a certain area that exceed a selected height level, or by manually identifying and editing out the unwanted laser hits. The triangulated terrain model, in contrast to the point cloud, might therefore not be a fully objective rendering of reality but rather an interpretation. Thus when editing the dataset, an

explicit clarification of what objects or anomalies have been deleted manually and in what way, or to what extent automatic filtering has been employed, would be of significance. This additional information could, of course, be combined with the possibility of using software that can display the original point cloud data in the same view as the final 3D model in order to help with clarifying any questionable areas. Such tools are at present limited to specialised add-on software, however, and are not directly available in CAD or GIS products.

As suggested above, one of the reasons for scanning the stone setting at Sommaränge skog was to see if scanning could be used as a fast and easy substitute for some of the time-consuming traditional documentation procedures. The results were quite satisfactory in broad outline, and it was actually possible to extract polygons out of the point cloud in a much faster and easier way than when drawing them by hand, and the polygons obtained did pretty well resemble the outlines of the stones (Fig. 10). When it came to details, however, it proved difficult to separate properly those stones that lay close to one another, and some of them came to be merged together in the wrong way. It has been suggested, though, that this problem might be avoided if the monument is scanned in more detail than was done in this case. That would also prevent the shadows or "blind spots" that occurred behind some of the stones. On the other hand, there is good reason to question whether there is any need for a two-dimensional drawing at all when a detailed, high-resolution 3D model is available. Such a model would of course depict the stone construction far more distinctly and accurately than any drawing, whether made by hand or by computer.

Regarding the cup-marked boulder, it can be noted that, when scanned at the right angle and using artificial light, the three pits appear quite clearly in the 3D model by comparison with the photograph (Fig. 11–12). Thus 3D laser scanning can indeed be an adequate way of documenting petroglyphs without using paint or photography. A "pulsed time-of-flight" laser ranging scanner such as the Cyrax 2500 is not the proper tool to use, however, if the aim is to get a detailed and complete picture of cup-marks, rock carvings or the like. A triangulating scanner would probably be more appropriate for the accurate recording of such fine details. Triangulating laser scanners typically have a very high resolution, making them ideal for short distances and the scanning of small objects.

Laser scanning is by no means a complete or adequate substitute for traditional methods of documentation

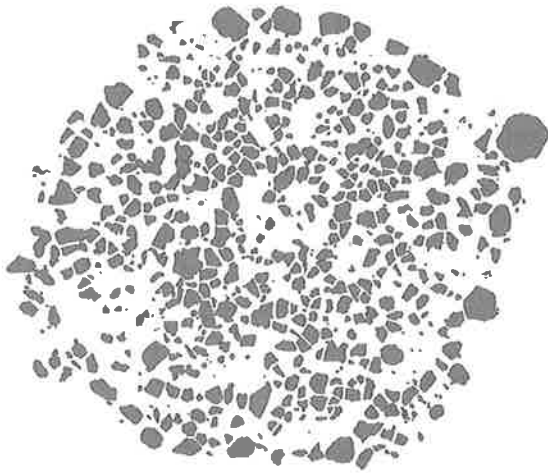

Figure 10. 2D mapping of the scanned stone setting (Ø15 m) at Sommaränge skog. The polygons were extracted automatically from the point cloud.



Figure 11. Photograph of the cup-marked boulder (0.80×0.65 m) at Sommaränge skog.

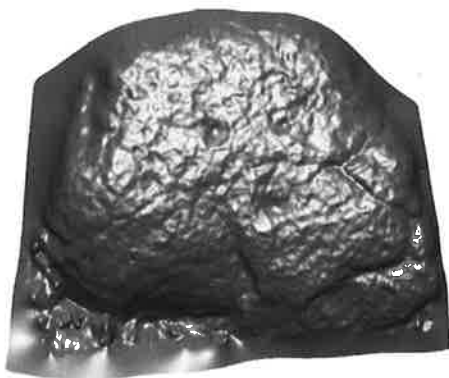

Figure 12. Scanned model of the cup-marked boulder at Sommaränge skog.

such as drawing by hand, photography or mapping with a total station or GPS, at least not yet. Although terrestrial laser scanning can actually offer fast and precise measurements or a well-nigh naturalistic renderings of certain objects, the technique also deprives the archaeologist to a certain degree of the sometimes necessary possibility of interpretation at the recording stage. The measuring or drawing of an archaeological object often requires more than just a comprehensive rendering of differences in terms of x, y and z coordinates. In addition it usually requires judgement and the demarcation of contexts according to features such as the frequency of finds, colour changes or soil types. Even though a laser scanner is a fairly advanced measuring device, the raw data produced (i.e. the point cloud) will be no more than a rendering of laser pulse hits on surfaces as actually seen by the system. This means that the interpretation phase is to some extent lost in the process of scanning and of course has to be carried out manually at the time of excavation, i.e. one still has to go out and perform traditional mapping as well. However, a combination of traditional mapping, archaeological experience and the technical superiority of laser scanning when it comes to speed, accuracy and efficiency can indeed be used to ease the interpretation and the subsequent analysis. If the technique can be improved even more and scanners and the related software become cheaper and easier to handle, this could certainly become a handy everyday tool for use in field archaeology. Nevertheless, it will probably still be considered just a complement to traditional measuring devices for a long time to come.

### Concluding remarks

Laser scanning may indeed be a useful tool in the archaeological fieldwork as well as for the analysis and interpretation of archaeological findings and environments. It offers a means for fast, detailed and effective documentation of large areas and also of smaller objects in a three-dimensional digital environment. Scanning a single object such as a cairn, mound or pit is a fast way of obtaining an exact documentation in three dimensions and provides an opportunity to make measurements and calculations (of volumes, for example) based on the digital model itself. Regarding the scanning of larger objects, such as the whole area of an excavation, the method seems of major value only insofar as the terrain is fairly undulated or hilly, especially if the archaeological objects are related to the topographic variations in a significant way. Hence scanning a large flat area in three dimensions might

seem somewhat pointless no matter how many hearths or postholes might be found there. On the other hand, the possibilities for turning and zooming the models in precisely the desired way makes them highly suitable for public display and interactive activities, and they can also be connected to databases or published on the Internet, either as figures or as interactive animations, together with other relevant information.

## Acknowledgements

Thanks are extended to Stiftelsen SAU:s forskningsråd for a grant which made this collaborative project possible, and also to Kicki Martinelle for helping out with the ArcGis application, to Camilla Forsman and Alexander Engström for reading the manuscript and to Mikael Östlund at the GIS Institute at Högskolan i Gävle for putting a great deal of effort and time into the 3D modelling and computer hacking and for always patiently answering questions and providing additional data.

*English language revision by Malcolm Hicks.*

## References

- Ahmon, J. 2004. The Application of Short-Ranged 3d Laser Scanning for Archaeological Replica Production: The Egyptian Tomb of Seti I. *The Photogrammetric Record* 19, Issue 106, p. 111.
- Blais, F. 2003. A review of 20 years of range sensor development. In S. El-Hakim, A. Gruen & J. S. Walton (eds.): *Videometrics VII: Proceedings of IS&T/SPIE's 15th Annual Symposium, Electronic Imaging, 20–24 January 2003, Santa Clara, California, USA*. Vol. 5013, pp. 62–76.
- Brayne, B., Carty, A., Cribbs, P., Goskar, T. A. & Vickers, D. 2003. The Stonehenge Lasershow. *British Archaeology* Issue 73, pp. 9–15.
- El-Hakim, S., Fryer, J., Picard, M., Whitting, E. 2004. Digital recording of aboriginal rock art. *10th International Conference on Virtual Systems and Multimedia (VSMM), Ogaki City, Gifu, Japan, 17–19 Nov. 2004*, pp. 344–355.
- English Heritage. 2005. Internet website, accessible 22 August, 2005 at: <http://www.english-heritage.org.uk/server/show/nav.1239>
- Forsman, C. & Victor, H. 2007. *Sommaränge Skog. Begravningar, ritualer och bebyggelse från senneolitikum, bronsålder och folkvandringstid. Rapport del 1: de förhistoriska lämningarna vid Sommaränge skog, RAÄ 211, Viksta sn, Uppland*. SAU Skrifter 18. Uppsala.
- Guinard, M. & Vogel, P. 2006. *Skallmyran: en senmesolitisk skärgårdslokal i Uppland*. SAU Skrifter 14. Uppsala.
- Kitzler Åhfeldt, L. 2002. *Work and Worship. Laser Scanner Analysis of Viking Age Rune Stones*. Theses and Papers in Archaeology B:9. Archaeological Research Laboratory, Stockholm University.
- Point of Beginning. 2005. *2005, 3D laser scanner survey*. Internet website, accessible 10 May, 2005 at: <http://www.pobonline.com/POB/FILES/HTML/PDF/POB0105-LaserScanning-Survey.pdf>
- Schmidt Wikborg, E. 2006. *Från gård och grund uppå Sommaränge skog medeltida bebyggelselämningar i Viksta socken, Uppland: rapport del 2 för undersökningar vid Sommaränge skog, RAÄ 211, Viksta sn, Uppland: de historiska lämningarna*. SAU Skrifter 15. Uppsala.
- Smith, J. R. 1997. 50 years of Geodimeter: Prototype GEOdetic Distance METER successfully used in 1947. *GIM International* 11(6), pp. 20–21.
- Wessex Archaeology/Archaeoptics. 2005. Internet website, accessible 10 May, 2005 at: <http://www.stonehengelaserscan.org>